

1. Introduction

A To install the A-190 please look at the important information on p. 4!

The **A-190** is a **MIDI-CV/SYNC Interface**, with which you can control any A-100 Module which has CV and gate/trigger input sockets by MIDI.

The A-190 has **two Digital-to-Analogue converters** (DAC for short), which put out control voltages from 0 V to +5 V, so that you can control not just the pitch, but also another voltage-controllable parameter on the A-100.

DAC 1 is 'hard-wired' to receive MIDI **note messages** and convert them into control voltages available at CV output socket **CV 1**. The DAC has 12-bit resolution, which gives excellent tuning resolution (in steps of 1/4096th). As a rule, DAC 1 will be used to **control VCO pitch**.

DAC 2 can be assigned to your choice of **MIDI controller**. This DAC has 7-bit resolution (1/128th steps). Its

output is available at **CV 2**, and can be used for voltage control of any suitable module (eg VCF, VCA, etc.).

The A-190 also has a **clock output**, controlled by **MIDI clock**. This can be divided down to provide a variety of clock outputs, and enable older sequencers or drum machines to be synced to MIDI.

A **Reset Output** provides control of the A-160 / 161 Clock Divider / Sequencer or can produce MIDI-synchronised gates (for instance on an ADSR). MIDI START or CONTINUE messages make the voltage at the Reset output go low, and MIDI STOP messages make it go high.

In addition, the A-190 allows for **portamento** (glide) and **pitch-bend**, and provides a software **LFO**. These functions can all be switched on and off or altered by MIDI controllers.

All control parameters can be saved in **non-volatile memory**.

H The A-190 needs an additional power supply (+5 V / 50 mA) for connection to the system bus.

2. A-190 - Overview

Controls and indicators

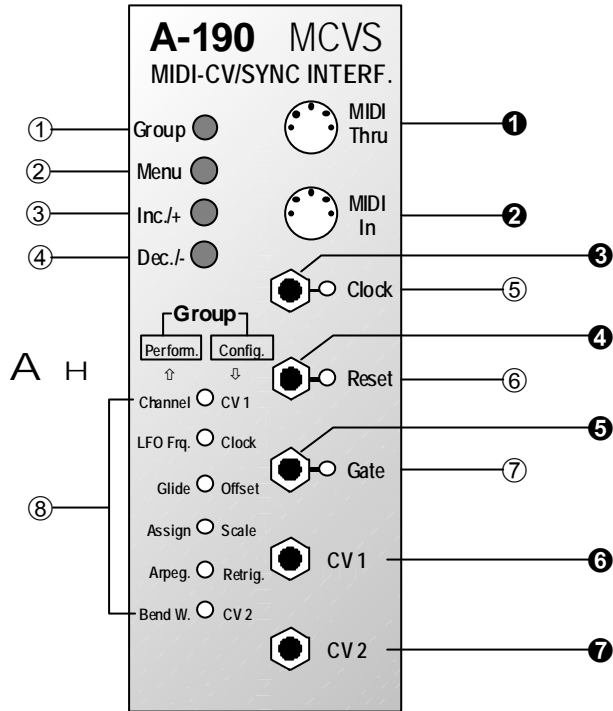

- 1 **Group** : Button to select which menu section (out of the Config and Performance menus), is available for editing
- 2 **Menu** : Button to select items in Edit Mode, choose items to be edited, and select items in Performance Mode
- 3 **INC / +** : Button for increasing a parameter value by one step at a time
- 4 **DEC / -** : Button for decreasing a parameter value by one step at a time
- 5 **Clock** : LED clock signal indicator for output S
- 6 **Reset** : LED reset signal indicator for output \$
- 7 **Gate** : LED gate signal indicator for output %
- 8 **LEDs** : Indicate the menu selected in edit mode

In / Outputs

- ! **MIDI THRU** : Output for relaying MIDI messages sent to MIDI IN to another MIDI unit.
- " **MIDI IN** : Input for MIDI messages.
- § **Clock** : MIDI clock signal (or divided version) output.
- \$ **Reset** : Reset signal output:-
MIDI-Start or Continue): low voltage
MIDI-Stop: high voltage.
- % **GATE** : GATE signal output; normally connected internally to the A-100 system bus (INT.GATE line), but can be disconnected.
- & **CV 1** : Output for control voltage 1 (D/A converter 1); normally connected internally to the A-100 system bus (INT. CV line), but can be disconnected.
- / **CV 2** : Output for control voltage 2 (D/A converter 2).

H N.B.:

On the front panel, the arrows were accidentally printed the wrong way round.

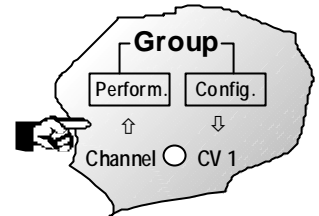

In these instructions, though, all the functions, for instance selecting a menu group, are described correctly (see p. 6).

3. Starting to use the A-190

Before switching your system on, use a MIDI cable to

A N.B. if you're using more than one A-190:

The A-190 is normally connected up to the INT.CV und INT.GATE on the system bus.

If you want to run **more than one A-190** with only a single system bus, then only one of the A-190s must be connected to the system bus.

Disconnect the other A-190 modules from the system bus, by cutting the **two** links labelled **CV1** and **GATE** (near the bus ribbon connector on the A-190 board).

connect between your MIDI instrument and the A-190:

- D Connect the A-190's input socket MIDI IN " to the MIDI OUT socket of your MIDI instrument (master keyboard, MIDI synth, MIDI sequencer, etc.).
- D Now switch your System A-100 on. The Gate LED 7 will briefly light up, to show you the A-190's software version (one blink = Version 1, etc.).

- D Patch the outputs of your A-190 to corresponding modules on the System A-100:

- H The **gate output** % and **CV1 output** & are automatically connected to the system bus of the A-100, so don't use patch cables to connect these, unless you have cut the links, or wish to connect to a module whose system bus isn't connected with the A-190's (have a look at the note on using more than one A-190). VCOs on the same system bus automatically receive CV1, and ADSRs automatically receive the gate signal.

Output	Connection notes
/ CV 2	Any module's CV input (for instance a VCF's CV input, for controlling the filter cut-off point).
§ Clock	For instance, the A-160's trigger input for MIDI-synced sequences.
\$ Reset	The A-160's reset input, for MIDI control of start and stop messages; the A-140's gate or retrigger input for MIDI-synchronised envelopes.

- D Use the CONFIG and PERFORM menus to tailor the MIDI set-up to your requirements.

4.1 Using the A-190

On power up, the A-190 defaults to **Performance mode**. This is the normal mode of operation, in which the incoming MIDI information is converted to CV, gate and clock signals, according to the A-190's settings. You can check you're in performance mode by seeing if all the **menu LEDs** (8) are **off**. The gate LED 7, reset LED 6 and clock LED 5 will light up in response to MIDI activity:



Since the A-190 gives you so many options for changing the way MIDI information is converted, it was necessary to use a menu system for setting the various parameters. There are two groups of menus, with six menus in each.

The **performance menus** are where you can change important **playing parameters** such as bend width and portamento time - the sort of parameters to which you need easy and frequent access .

The **Config menus**, on the other hand, contain **configuration parameters**, which are fundamentally important to the whole MIDI set-up, but as a rule don't need to be changed often (for instance gate polarity, voltage response, or re-trigger time).

To alter parameters, you need to be in **edit mode**. The procedure is as follows:

- Select the menu group
- Switch to edit mode
- Select the menu which contains what you want to edit
- Alter the parameters either manually or by MIDI
- Return to performance mode.

Selecting menu group

The A-190 is designed so that, after power up, the first time you enter edit mode, you automatically go to the performance menu group.

Pressing the **Group** button 1 switches to the other menu group - the button acts as a toggle switch. A mini-light-show indicates which group is selected:

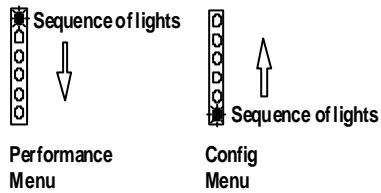

For example, if, after switching on, you need to alter GATE POLARITY in Config Menu 1, press the **Group** button 1 once. The light sequence goes upwards from the bottom LED, and tells you that when you press the edit button you will be in the Config Menu.

Changing to edit mode

When in performance mode, switch over to **edit mode** by pressing the **MENU** button 2. The **top LED flashes**, to tell you that you're in edit mode, and can now access the parameters in the first menu in the group you selected with the group button:



You can tell which **menu group** you're in by checking the **speed at which the LED (8) blinks**:

slow blink : **Config** menu

fast blink : **Performance** menu

H (Symbols in the text: 0 : slow
2 : fast)

Menu selection

If the parameter you want to edit isn't in the first menu, scroll through the other menus by repeatedly pressing the **MENU** button 2 (see the diagram on the next page).

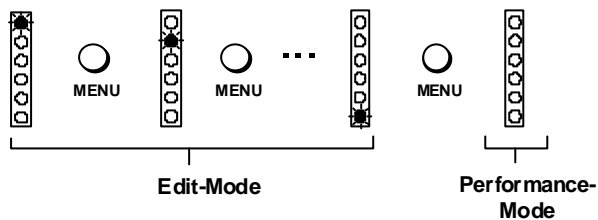

Changing parameters

There are two ways of changing parameters on the A-190: either manually, or by sending the appropriate MIDI messages, which the A-190 'learns'. Whenever possible, use the latter method, 'MIDI learning'. In chapters 4.2 and 4.3, the symbols **M** (MIDI learning) and **m** (manual) show the different methods possible.

In **manual** mode, use the **INC** button 3 to increase a parameter by one, and the **DEC** button 4 to decrease it by one. All the LEDs flash once together each time a change is made.

In **MIDI learning** mode, parameters are changed by sending appropriate MIDI messages to the A-190. For example, in Config menu 1, the MIDI message "PROG CHANGE 3" switches CV CHAR. (the type of pitch control voltage sent out) to V/Octave.

Switching back to performance mode

When you've made the change to the parameter you wanted to alter, you can either change other parameters in the same menu, or go on to the next menu by pressing **MENU** button 2. Repeatedly pressing the **MENU** button takes you through all the menus, and then back to performance mode - signified by all the menu LEDs (8) being off (see the diagram at top left).

H If you've edited a parameter in one menu group, and want to edit one in the other, it's necessary to go back to performance mode first. Then you can press the **Group** button 1 to switch to the other menu group.

H You can find a **table** showing all the **parameters** in the CONFIG and PERFORMANCE menus, as well as all the **MIDI controllers**, on page 23.

4.2 CONFIG menus

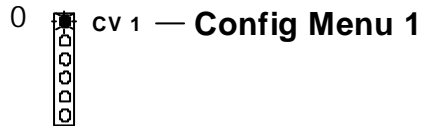

CHANNEL / REF. NOTE

The **CHANNEL** parameter sets the **MIDI receive channel**. In performance mode, MIDI messages received on this channel are converted to CV and gate signals and sent to whichever modules are connected to the A-190 - either via the system bus or via patch leads.

REF. NOTE sets the bottom note on the MIDI keyboard which will play the lowest note on the A-100 VCOs. As a rule, this is MIDI note number 36.

M **NOTE ON** **ch** **n** **vel**

ch : MIDI channel
n : MIDI note number

H Note that playing a note on the keyboard will set MIDI channel and bottom note at the same time.

This method of setting the MIDI channel is preferable to the performance mode method, which has no confirmation.

[m Change the bottom MIDI note (0 to 127)]

GATE POLARITY

This parameter sets the **polarity of the gate voltage**.

H For use with the A-100, this parameter should always be set to positive. The only time you may need to alter it is to control certain other makes of synthesizer.

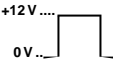
M **positive:**  **PROG CHANGE 1**

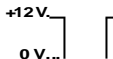
negative:  **PROG CHANGE 2**

CV CHAR.

This parameter sets the **voltage control characteristics** of the pitch CV output from the A-190, so that it's possible to drive both common types of analog synth - older Korgs, Yamahas, etc., which have a linear response (Hz / V), and Rolands, ARPs, Moogs, etc., which have a logarithmic response (1V / octave).

H For use just with the A-100, the V / octave response is all that is needed. The Hz / V option is provided purely for connecting to external synths which use that standard.

M V / Octave : **PROG CHANGE 3**

Hz / V : **PROG CHANGE 4**

RETRIGGER

This parameter enables you to choose between **single** and **multiple** triggering of the ADSR. With RETRIGGER on, every time a key is pressed, **another gate signal is sent**, even if (ie in legato playing) another key is still held down at the time.

M **OFF** : **PROG CHANGE 5**

ON : **PROG CHANGE 6**

H This parameter can also be changed in performance mode. If, even with RETRIGGER ON, the gate isn't reliably re-triggered, set a higher value for the **gate retrigger time** in CONFIG menu 5.



CLOCK TIME

This parameter sets the **amount by which the MIDI clock is divided** before being sent to the clock output S. (See 'note length' in the table below.)

MIDI Clock pulses are 1/96th Note. By setting the amount by which the clock is divided, you can choose different note lengths:

divisor	clocks per note	note length
1	96	1/96th
3	32	1/32nd
6	16	1/16th
12	8	1/8th
24	4	1/4

H You can also use the A-160 clock divider to produce different divisions.

M PROG CHANGE n

n : Divisor (1 ... 64)
on any MIDI channel

[m Increase or decrease the divisor]

CLOCK POLARITY

This Parameter sets the **polarity of the clock signals** at output S.

H For use just with the A-100, select "positive". The negative setting is provided just for connection to other synths that use a negative pulse.

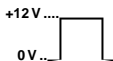
M **positive** :  **PROG CHANGE 65**

negative :  **PROG CHANGE 66**

Use any MIDI channel to make these changes.



REF. OFFSET

This parameter sets the **voltage offset** for the bottom note - and works in the same way as the VCO's Tune control. In normal use, this is set to 0 V.

m Increase or decrease the amount of voltage offset.

H The **INC-** and **DEC-** buttons speed up if you keep holding them down.



SCALE

This parameter sets the **fine scaling of the pitch-control DAC** so that MIDI and A-100 VCO notes are

completely in tune over their whole range (see diagram on page 12).

After setting the bottom note and voltage offset, you send a MIDI note to the A-190 - usually the note exactly an octave or several octaves above the bottom note. Using the SCALE parameter, adjust the voltage sent to the VCO to ensure that the **octaves are completely in tune**.

H For use just with the A-100, it may well be fine to leave this at the standard factory setting of exactly 1.00 V / octave.

m Increase or decrease the amount of voltage offset on the higher note.

H The **INC-** and **DEC-** buttons speed up if you keep holding them down.

In the example on page 12, after the V / octave response, bottom note (MIDI note 36) and voltage offset (0 V) have been set, the SCALE parameter is adjusted so that when MIDI note 84 (exactly four octaves above the bottom note) is received, the VCO note played is precisely four octaves higher. (That is, the pitch CV is exactly four volts.)

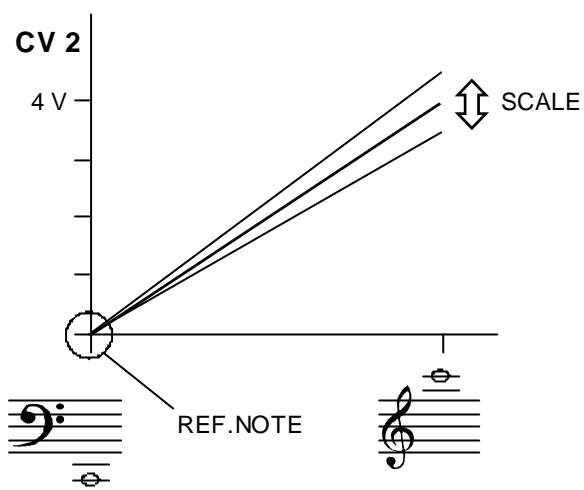

0  Retrig. — **Config Menu 5**

RTRIG. TIME

This parameter sets the **gate retrigger time** - ie. the time that elapses before another gate signal received triggers the envelopes.

When setting this, always start with the shortest possible retrigger time (1 ms), and see if the connected module (eg. an ADSR) triggers. If it doesn't, slowly increase RTRIG.TIME until the module does respond to each new gate.

M PROG CHANGE n

n : 0 ... 127 RTRIG.TIME = n x 1 ms

[m Increase or decrease the time in 1ms steps
(0 to 255)]

0  cv 2 — **Config Menu 6**

ASSIGN CV2

This parameter sets which MIDI message is sent to **DAC 2**, and thus to the **CV2 output socket**. The voltage output range is from 0 to +5 V.

M	Number for manual setting	MIDI-Event
	0	Velocity *
	1	Program Change
	2	Controller #n
	3	Pitch Bend
	4	channel aftertouch
	5	polyphonic aftertouch

* a Note On/Off message must be sent

[m Manual assignment (0 to 5)]

H Note that you can make the A-190 learn **whatever MIDI controller you choose** as the source for DAC 2, simply by sending it via MIDI IN while in Config menu 6.

For instance, if you move the data entry control (MIDI Controller # 6) on your master keyboard while the A-190 is in Config menu 6, this controller is assigned to DAC 2, so that whenever it is moved, CV2's voltage changes correspondingly. This is equally true for Main Volume (MIDI Controller #7), Breath Controller, Foot Controller, etc.

If the resulting voltage change is too obviously quantised (because MIDI has only 128 steps), then the steps can be smoothed out with an A-170 slew limiter (see the diagram).

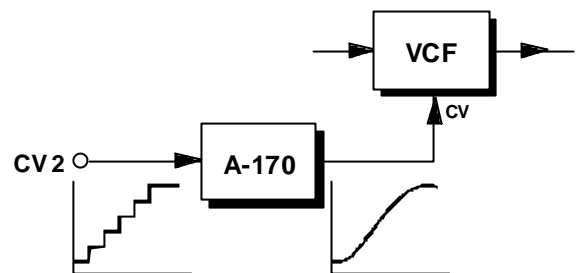

4.3 PERFORMANCE Menus

2 Channel — Performance Menu 1

CHANNEL

The **CHANNEL** parameter sets the **MIDI receive channel**. MIDI messages received on this channel in performance mode are converted into CV and gate signals and output to whatever modules are connected to the A-190.

[m Set the MIDI channel (1 to 16)]

H It's better to set MIDI channel by a MIDI message in **config menu 1**, where control is more direct.

2 LFO Frq. — Performance Menu 2

LFO FREQ.

The LFO Freq. parameter controls the frequency of the A-190's **built-in LFO**.

Use your ears to decide the correct frequency. With a parameter value of **less than 3**, the LFO is **switched off**.

m Set the LFO frequency
(from about 0.2 Hz to 20 Hz)

H The **INC-** / **DEC-** buttons will speed up if you keep them pressed down.

H With the A-190, you're effectively getting an extra software LFO, controlled over MIDI, which can supplement the 'real' LFOs (A-145, A-146) in your A-100 system.

2  **Glide — Performance Menu 3**

GLIDE TIME

The Glide Time parameter controls the length of the **portamento time** in the A-190's built-in glide / portamento function, in steps of 20ms at a time.

M **PROG CHANGE n**

n : 0 **Glide Off**
 1 ... 127 **Glide On,**

GLIDE-TIME = n x 20 ms

Any channel can receive the message.

[m Set the glide time (0 ... 127) **]**

H This parameter can also be controlled in real time by means of the MIDI portamento controller (Controller #5). See chapter 4.5, PERFORMANCE mode.

H This MIDI function is like a software version of the A-170 Slew Limiter.

2  **Assign — Performance Menu 4**

ASSIGN MODE

The **ASSIGN MODE** parameter controls **note assignment** - that is, which note the VCO should produce when more than one key is held down at once.

M **Last Note Priority: PROG CHANGE 1**

Highest Note Priority: PROG CHANGE 2

Any channel can receive the message.

[m Select which type of note priority you want **]**

2  Arpeg. — Performance Menu 5

No function at present

Reserved for future expansion (e.g. arpeggiator)

M The pitch bend range is set by the **interval** between two MIDI notes played in succession:

Reference note: set by the first **NOTE ON**

Range note: set by the second **NOTE ON**

Any channel can receive the message.

2  Bend W. — Performance Menu 6

[m Set the pitch bend range **]**

BEND WIDTH

The BEND WIDTH parameter sets the **pitch bend range**. For example, if you set the range to a whole tone, the pitch bender on your MIDI instrument will alter the A-100's VCO pitch by a maximum interval of a semi-tone up or down.

4.4 Storing set-ups

The A-190 is equipped with a **non-volatile memory** (EEPROM - electrically eraseable programmable read-only memory!) which will store your set-up ready for when you switch the system back on.

If you just change the settings of various parameters, the A-100 only stores these changes **temporarily**, and they'll be lost when you switch the A-100 off. To store any changes in the set-up, you have to **save** the set-up, by simultaneously pressing both the **INC-** and **DEC-buttons**. The A-190 **signals that the save procedure has been successful** in the following way :

- All LEDs **light up** while you press the buttons.
- All LEDs blink slowly for around three seconds.
- All LEDs blink quickly for around three seconds.
- The **save procedure** is then completed, and all the **LEDs go out**. The next time the A-100 is switched on, the set-up will be recalled.

It's possible to **abort** the save procedure, by pressing any button while the LEDs are still blinking. In this case, all parameters revert to how they were before the save procedure started.

H It's a much better idea to carry out the **save procedure** in **PERFORMANCE mode** (indicated by all menu LEDs 8 being off).

If you carry out this procedure in EDIT mode (shown by one of the menu LEDs blinking) there's always the danger of the active parameter being increased or decreased by one step the instant before it's saved, because of the physical difficulty of pressing the **INC** and **DEC** buttons at precisely the same time.

It's always possible to alter the default set-up with which the A-190 leaves the factory (see chapter 4.6, Initialisation).

4.5 PERFORMANCE mode

In **performance mode** the A-190 converts incoming MIDI messages into CV and gate signals. As well as those already mentioned in chapter 4.4, it also recognises and converts the following controller messages. (H "ch" is short for 'MIDI channel').

CONTROLLER #01 (Modulation)

This controller affects modulation intensity - ie. the amount of LFO voltage included in CV1.

M **CONTROL** **ch** **01** **n**

n : 0 to 127

CONTROLLER #05 (Portamento Time)

This controller affects **portamento time** (see PERFORMANCE menu 3). Changes made using this controller are only temporary: they are not stored during the 'save' procedure, and on power-up, the A-100 will revert to the default factory setting.

M **CONTROL** **ch** **05** **n**

n : 0 to 127 Portamento time

CONTROLLER #64 (Sustain)

This controller switches **sustain** on and off.

M **CONTROL** **ch** **64** **n**

n : 0 to 63 Sustain Off
 64 to 127 Sustain On

CONTROLLER #65 (Portamento)

This controller switches **portamento** on and off.

M **CONTROL** **ch** **65** **n**

n : 0 ... 63 Glide Off
 64 ... 127 Glide On

CONTROLLER #68 (Legato)

The **retrigger function** (see CONFIG menu 1) can also be switched on and off by this controller. Changes made using this controller are only temporary: they are not stored during the 'save' procedure, and on power-up, the A-100 will revert to the default factory setting.

M **CONTROL** **ch** **68** **n**

n : 0 to 63 Retrigger Off
 64 to 127 Retrigger On

CONTROLLER #92 (Tremolo)

This controller can affect **LFO frequency** (see PERFORMANCE menu 2). Changes made using this controller are only temporary: they are not stored during the 'save' procedure, and on power-up, the A-100 will revert to the default factory setting.

M **CONTROL** **ch** **92** **n**

n : 0 to 127 LFO frequency

CONTROLLER #121 (All Controllers Off)

If this MIDI message is sent to the A-190, **LFO amount** will be set to 0 (although the LFO keeps running at the same frequency) and **portamento** is switched off.

M **CONTROL** **ch** **121** **n**

n : 1 to 127

CONTROLLER #123 (All Notes Off)

If this MIDI message is sent to the A-190, the **gate** is turned off, and **all notes still in the A-190's memory** are cleared. Control voltages remain at the level at which they were last set.

M **CONTROL** **ch** **123** **n**

n : 1 to 127

4.6 Initialisation (Reset)

When the A-190 is first switched on after leaving the factory, its memory is **initialised** - that is, all parameters are set to their **standard default values** (see the **table** on page 21).

You can always perform a **reset**, and return the A-190 to these **standard factory settings**. There are two forms of reset available:

- a. Only the parameters marked "★" in the table are reset.
- b. All the parameters in the table are reset.

For partial reset 'a', do the following:

- D Switch the System A-100 off.
- D Keep the menu button 2 pressed, while turning the A-100 power back on.

The A-190 will **confirm the partial reset** by **flashing** all its LEDs (8) **slowly** for about five seconds.

For the full reset 'b', do the following:

- D Switch the System A-100 off.
- D Press and hold buttons 1 to 4, while turning the A-100 power back on.

The A-190 will **confirm the full reset** by flashing all its LEDs 8 **slowly** for about five seconds, **then quickly** for another five seconds.

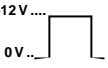
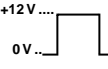
	Parameter	Value	Notes
★	CHANNEL	0	MIDI channel 1
	REF. NOTE	36	C3
	CLOCK TIME	1	clock frequency at output \S = MIDI clock frequency
	CLOCK POLARITY	0	positive: 
	RETRIGGER	0	legato - ie. no retrigger
	LFO FREQ.		c. 3 Hz
	GLIDE TIME	0	no portamento
	BEND WIDTH	12	1 octave
	ASSIGN CV2	0	velocity
	ASSIGN MODE	0	highest note
	SCALE		1.00 V / octave
	REF. OFFSET		0 V
	GATE POLARITY	0	positive: 
	RTRIG. TIME	4	4 milliseconds
	CV CHAR.	0	1 V / octave

5. Patch-Sheet

The following diagrams of the module can help you recall your own **Patches**. They're designed so that a complete 19" rack of modules will fit onto an A4 sheet of paper.

Photocopy this page, and cut out the pictures of this and your other modules. You can then stick them onto another piece of paper, and create a diagram of your own system.

Make multiple copies of your composite diagram, and use them for remembering good patches and set-ups.

- P
- Draw in patchleads with colored pens.

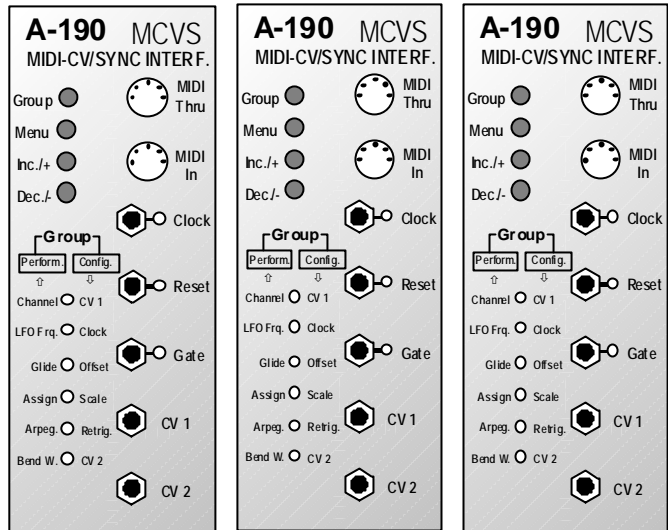

CONFIG menu				PERFORMANCE menu			
No.	Parameter	Setting	Default	No.	Parameter	Setting	Default
1	CHANNEL	NOTE ON ch n vel	1	1	CHANNEL	m INC / DEC	1
	REF. NOTE	NOTE ON ch n vel	C3	2	LFO FREQ.	m INC / DEC	~ 3 Hz
	GATE POL.	pos.: PROG CHG 1 neg.: PROG CHG 2	pos.	3	GLIDE TIME	PROG CHG n TIME= n x 20 ms	0 V
	CV CHAR.	V / octave: PROG CHG 3 Hz / V : PROG CHG 4	V / Okt	4	ASSIGN MODE	Last Note: PROG CHG 1 Highest Note: PROG CHG 2	Highest
	RETRIGGER	OFF: PROG CHG 5 ON: PROG CHG 6	OFF	5	ARPEG.	no function at present	-
2	CLOCK TIME	PROG CHG n n = Divisor	1	6	BEND WIDTH	Reference note: first NOTE ON Range note: second NOTE ON	1 Octave
	CLOCK POL.	pos.: PROG CHG 65 neg.: PROG CHG 66	pos.	MIDI controllers in PERFORMANCE mode			
3	REF. OFFSET	m INC / DEC	0 V	Controller Effect Setting			
4	SCALE	m INC / DEC	1.00	Cont 01 n	Modulation	n = LFO voltage amount sent to CV 1	
5	RETRIG. TIME	PROG CHG n RETRIG.TIME = n x 1 ms	4 ms	Cont 05 n	Glide Time	Portam. Time = n x 20 ms	
				Cont 64 n	Sustain	n = 0 to 63 : Off n > 63 : On	
6	ASSIGN CV 2	m M 0 Velocity (NOTE ON/OFF) 1 Program Change 2 Controller #n 3 Pitch Bend 4 Channel Aftertouch 5 Polyphonic Aftertouch choice of MIDI controllers	Velocity	Cont 65 n	Glide	n = 0 to 63 : Off n > 63 : On	
				Cont 68 n	Retrigger	n = 0 to 63 : Off n > 63 : On	
				Cont 92 n	LFO Freq.	n = LFO frequency (CV 1)	
				Cont 121 n	All Cont. Off	n can be any number. LFO modulation amount = 0, Glide off	
				Cont 123 n	All Notes Off	n canbe any number. All notes off, GATE off	

